

VFD C2000



IABU Headquarters

Delta Electronics, Inc.
Taoyuan1
31-1, Xingbang Road, Guishan Industrial Zone,
Taoyuan County 33370, Taiwan, R.O.C.
TEL: 886-3-362-6301 / FAX: 886-3-362-7267

Asia

Delta Electronics (Jiang Su) Ltd.
Wujiang Plant3
1688 Jiangxing East Road,
Wujiang Economy Development Zone,
Wujiang City, Jiang Su Province,
People's Republic of China (Post code: 215200)
TEL: 86-512-6340-3008 / FAX: 86-512-6340-7290

Delta Greentech (China) Co., Ltd.
238 Min-Xia Road, Cao-Lu Industry Zone, Pudong, Shanghai,
People's Republic of China
Post code: 201209
TEL: 021-58635678 / FAX: 021-58630003

Delta Electronics (Japan), Inc.
Tokyo Office
Delta Shibadaimon Building, 2-1-14
Shibadaimon, Minato-Ku, Tokyo, 105-0012,
Japan
TEL: 81-3-5733-1111 / FAX: 81-3-5733-1211

Delta Power Solutions (India) Pte. Ltd.
Plot No. 28, Sector-34, EHTP
Gurgaon-122001 Haryana, India
TEL: 91-124-416-9040 / FAX: 91-124-403-6045

America

Delta Products Corporation (USA)
Raleigh Office
P.O. Box 12173, 5101 Davis Drive,
Research Triangle Park, NC 27709, U.S.A.
TEL: 1-919-767-3813 / FAX: 1-919-767-3969

Delta Products Corporation (Brazil)
Sao Paulo Office
Rua Itapeva, N° 26, 3° andar, Bela vista
ZIP: 01332-000 - São Paulo - SP - Brasil
TEL: 55-11-3568-3875 / FAX: 55-11-3568-3865

Europe

Deltronics (The Netherlands) B.V.
Eindhoven Office
De Witbogt 15, 5652 AG Eindhoven, The Netherlands
TEL: 31-40-2592850 / FAX: 31-40-2592851

107392, .7, .309
/ : (495) 661-24-41
E-mail: sales@deltronics.ru
http://www.deltronics.ru



Delta Electronics -

- VFD-C2000.
(FOC),

(Field Oriented Control)

MODBUS CANOpen
: PROFIBUS-DP, DeviceNet, MODBUS TCP Ethernet/IP

CE, UL cUL

(IP20/NEMA1)
: 230V 0.75...90 , 460V 0.75...355

230 ()	0.75	1.5	2.2	3.7	5.5	7.5	11	15	18.5	22	30	37	45	55	75	90
	A			B			C		D		E			F*		
460 ()	0.75	1.5	2.2	3.7	4.0	5.5	7.5	11	15	18.5	22	30	37	45	55	75
	A			B			C			D						
460 ()	90	110	132	160	185	220	280	315	355							
	E		F*		G*		H*									

II 2010



C2000

VFD-C FOC-

1. 600
- 2.
3. (/)
4. 4-
- 5.

- 1.
- 2.
- 3.
- 4.



- 1.
- 2.
- 3.
- 4.
- 5.

1. 50°
2. DC
- 3.
4. RFI -
5. (CE, UL, cUL)

■ (SVC),

■ VFD-C2000 (IEC61508), (EN954-1, EN60204-1)

■ FOC-

■ FOC- , 200%

FOC+PG

■ VFD-C2000

■ , VFD-C PDFF-

VFD-C

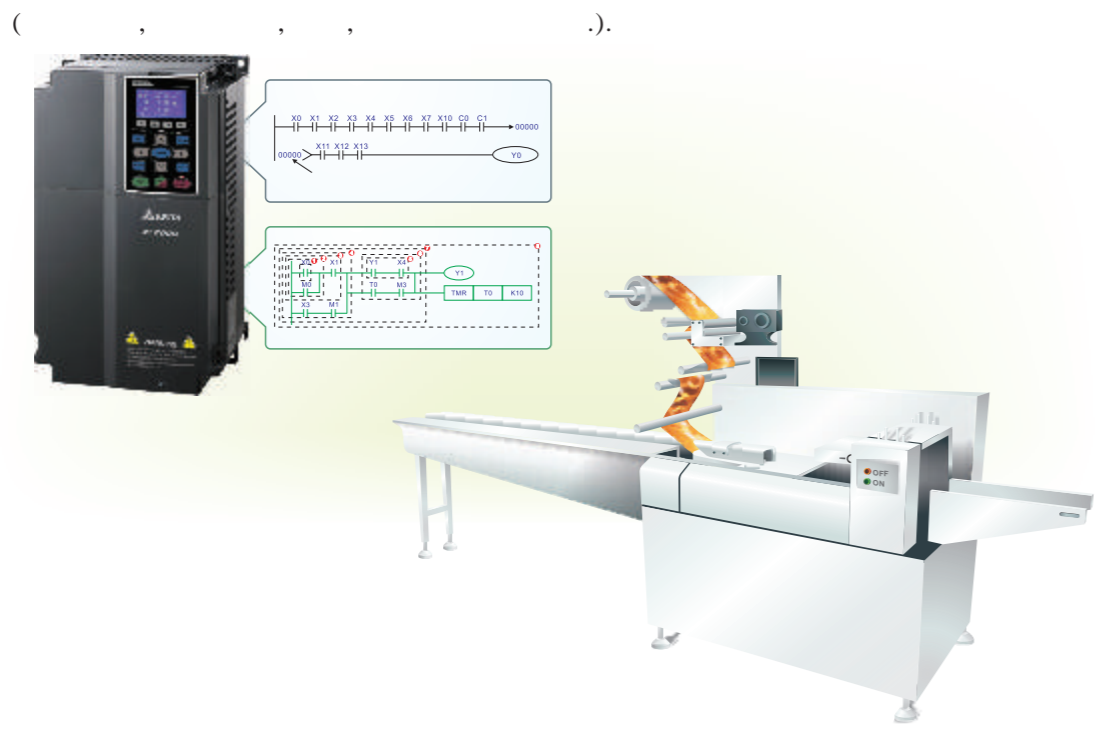

VFD-C2000

2- -1

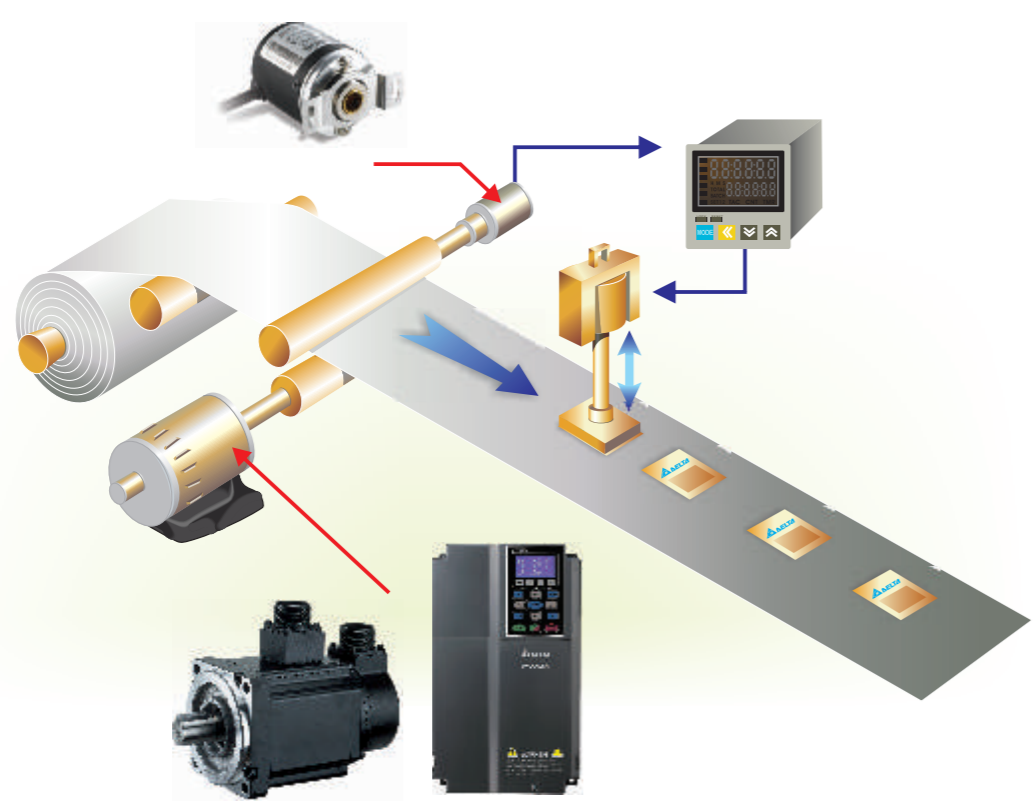

VFD-C

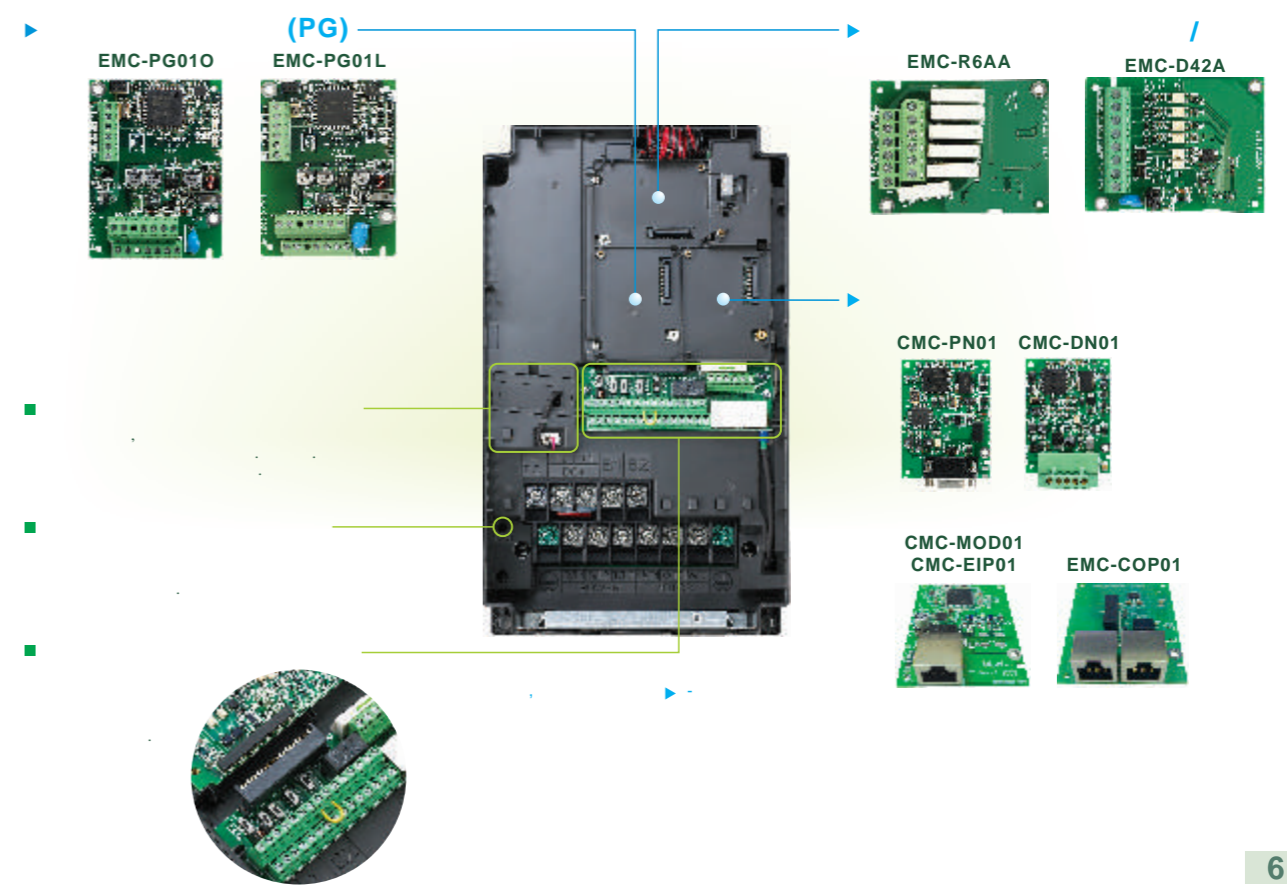

- RS-485



- CANopen (DS402),

Delta

CANopen Builder,
CANopen.

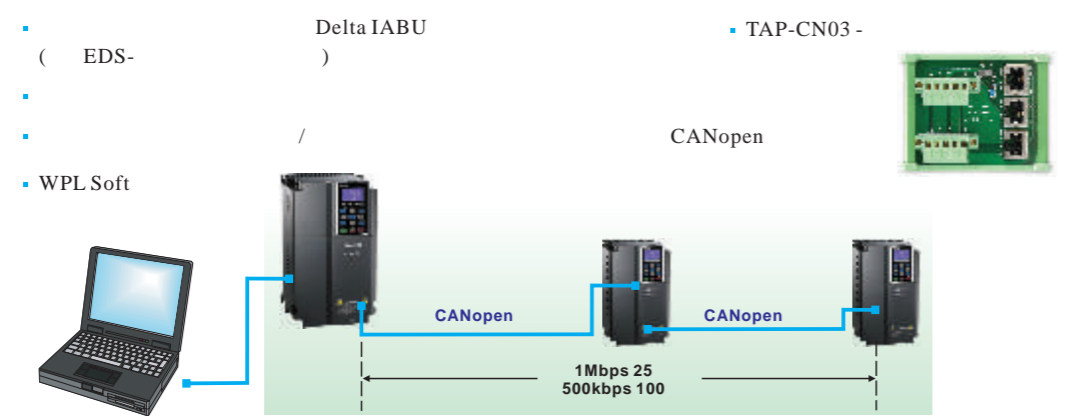

Delta DeviceNet Builder

DeviceNet

- (EDS-)
- DeviceNet



- MODBUS TCP

DCI Soft



Ethernet

- Delta Ethernet/Modbus TCP

COM-

- RFI- IEC/EN61000-3-2, 61000-3-12 61800-3.

-
-
-

- (1)
- (2)



-

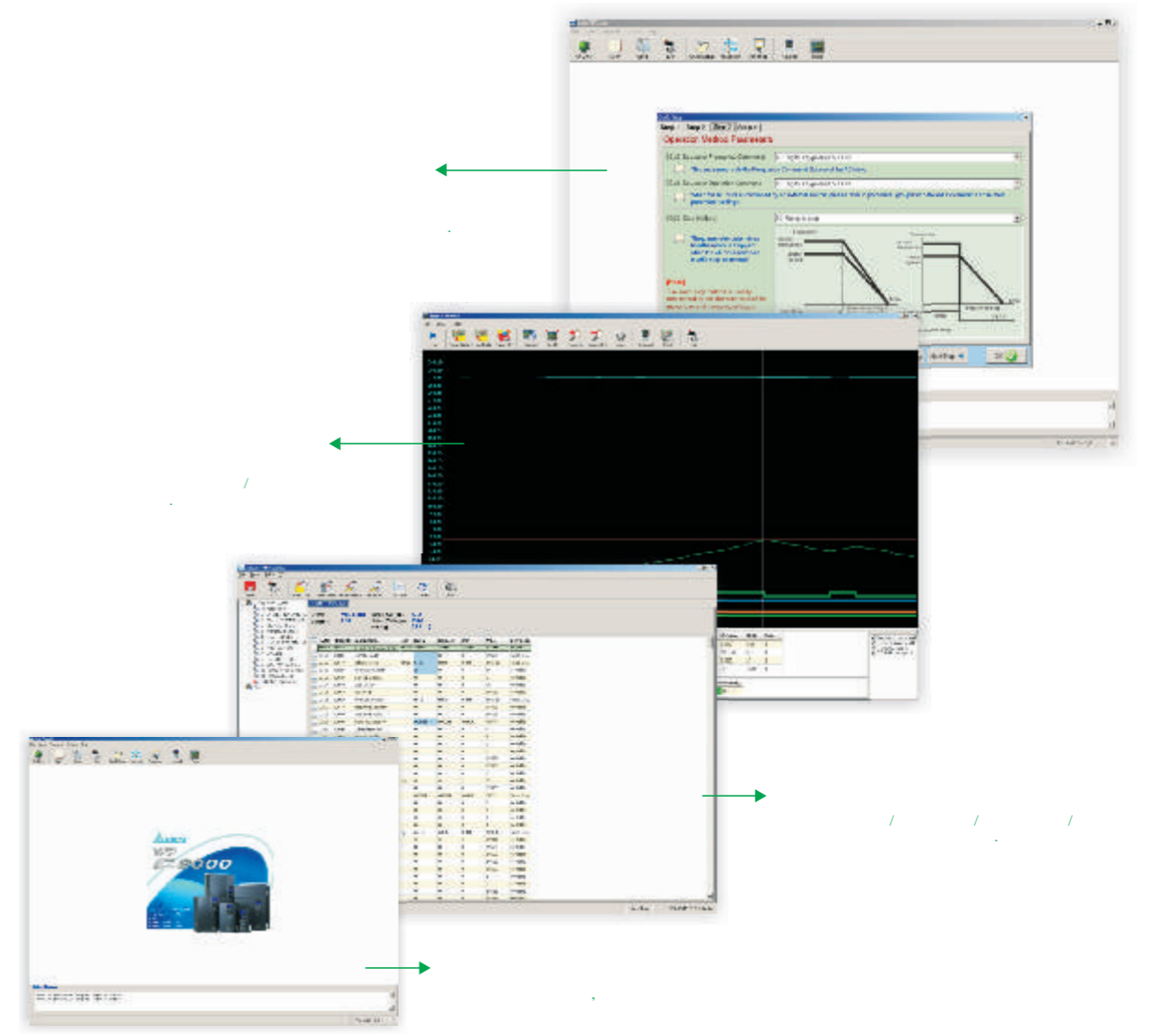

 <p>A</p>	230 : 0.75~3.7 (1~5HP)	VFD007C23A/E VFD037C23A/E VFD007C43A/E VFD015C43A/E VFD037C43A/E VFD040C43A/E VFD055C43A/E	▶ [MKC-AFM]
	460 : 0.75~5.5 (1~7.5HP)	VFD015C23A/E VFD022C23A/E VFD022C43A/E	▶ [MKC-AFM1]
 <p>B</p>	230 : 5.5~11 (7.5~15HP)	VFD055C23A/E VFD075C23A/E VFD110C23A/E VFD075C43A/E VFD110C43A/E VFD150C43A/E	▶ [MKC-BFM]
	460 : 7.5~15 (10~20HP)		
 <p>C</p>	230 : 15~22 (20~30HP)	VFD150C23A/E VFD185C23A/E VFD220C23A/E VFD185C43A/E VFD220C43A/E VFD300C43A/E	▶ [MKC-CFM]
	460 : 18.5~30 (25~40HP)		
 <p>D</p>	230 : 30~37 (40~50HP)	VFD300C23A VFD370C23A VFD370C43A VFD450C43A VFD550C43A VFD750C43A VFD300C23E VFD370C23E VFD370C43E VFD450C43E VFD550C43E VFD750C43E	▶ Conduit box kit [MKC-DN1CB]
	460 : 37~75 (50~100HP)		
 <p>E</p>	230 : 45~75 (60~100HP)	VFD450C23A/E VFD550C23A/E VFD750C23A VFD900C43A/E VFD1100C43A/E VFD750C23E	▶ Conduit box kit [MKC-EN1CB]
	460 : 90~110 (125~150HP)		
 <p>F</p>	230 : 90 (125HP)	VFD900C23A/E VFD1320C43A/E VFD1600C43A/E	2010 . II .
	460 : 132~160 (175~215HP)		
 <p>G</p>	460 : 185~220 (250~300HP)	VFD1850C43A/E VFD2200C43A/E	2010 . II .
 <p>H</p>	460 : 280~355 (375~475HP)	VFD2800C43A/E VFD3150C43A/E VFD3550C43A/E	2010 . II .

MODEL:VFD007C43A

INPUT:
Normal Duty: 3PH 380-480V 50/60Hz 4.3A
Heavy Duty: 3PH 380-480V 50/60Hz 4.1A

OUTPUT:
Normal Duty: 3PH 0-480V 3A 2.4KVA 1HP
Heavy Duty: 3PH 0-480V 2.9A 2.3KVA 1HP

FREQUENCY RANGE:
Normal Duty: 0-600Hz
Heavy Duty: 0-300Hz

Version: VX.XX

(IPXX)



007C43A7T9300002

DELTA DELTA ELECTRONICS, INC.
MADE IN XXXXXXX









VFD 007 C 43 A

23: 230V 3-
43: 460V 3-

C2000

007: 0.75 ~ 1100: 110

(Variable Frequency Drive)

	CMC-EIP01 CMC-MOD01		EtherNet/IP (CMC-EIP01) MODBUS TCP (CMC-MOD01) 10/100 / ,
	CMC-PN01		DP-PROFIBUS 9.6 / , 19.2 / , 96.75 / , 187.5 / , 500 / , 1.5 / , 3 / , 6 / 12 /
	CMC-DN01		DeviceNet 125 / , 250 / , 500 /
	EMC-COP01		CANopen 1 500k 250k 125k 100k 50k
	EMC-R6AA		(6)
	EMC-D42A		(4 2 /)
(PG)	EMC-PG01O		PG : V+ (, PLC) : 300
	EMC-PG01L		PG : : 5VDC : 50 : 300
	KPC-CE01		7- LED- , (MKC-KPPK) , IP56.

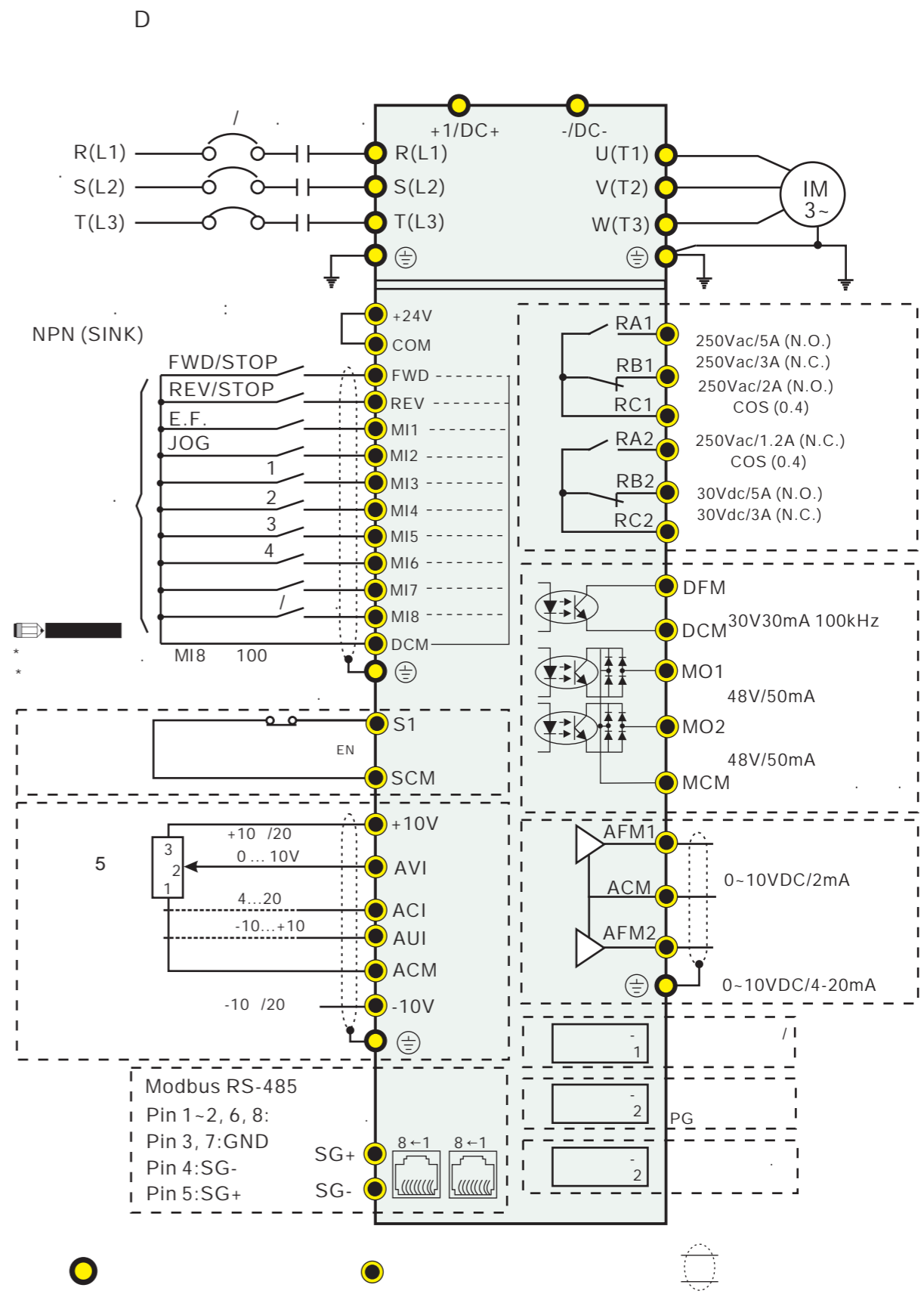
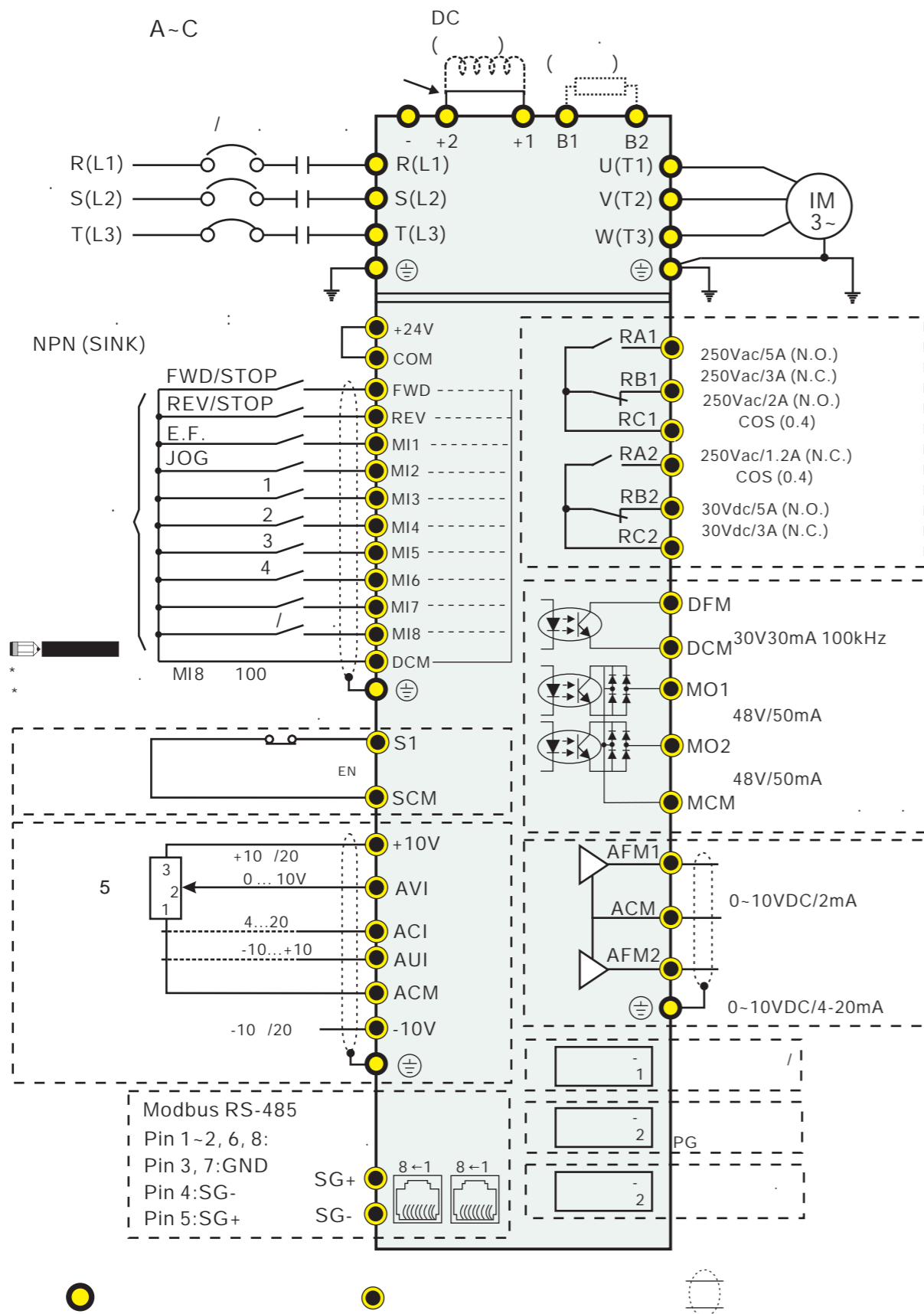

230V		A				B			C			D		E		
VFD-__C__		007	015	022	037	055	075	110	150	185	220	300	370	450	550	750
()	()	0.75	1.5	2.2	3.7	5.5	7.5	11	15	18.5	22	30	37	45	55	75
(..)	(..)	1	2	3	5	7.5	10	15	20	25	30	40	50	60	75	100
()	()	1.9	2.8	4.0	6.4	9.6	12	19	25	28	34	45	55	68	81	96
(A)	(A)	4.8	7.1	10	16	24	31	47	62	71	86	114	139	171	204	242
()	()	2-6														
()	()	2.0	3.2	4.4	6.8	10	13	20	26	30	36	48	58	72	86	102
(A)	(A)	5	8	11	17	25	33	49	65	75	90	120	146	180	215	255
()	()	2-15					2-10					2-9				
(A)	(A)	6.1	11	15	18.5	26	34	50	68	78	95	118	136	162	196	233
(A)	(A)	6.4	12	16	20	28	36	52	72	83	99	124	143	171	206	245
/	/	3- AC 200 (-15%)...240 (+10%), 50/60														
/	/	170-265Vac														
/	/	47-63														
EMI-	EMI-															

1: V/F, 2: SVC, 3: VF+PG, 4: FOC+PG	150%	0.5	150%	0	1
V/f	4				
5 ()	40				
.200%					
±5%					
()	: 0.01~600.00		: 0.00~300.00		
	: ±0.01%, -10...+40°		: ±0.1%, 25±10°		
	: 0.01		: 0.03/60 (±11)		
	: 120%		1		
	: 150%		1		
/	+10...-10, 0...10, 4...20, 0...20				
/	0.00...600.00/0.0...6000.0				
	,16				
	,S-				
	()				
MODBUS (RS-485 (RJ45))	.115.2 /)				
	B	/	C		
	: 240%				
	: 170~175%;		: 180~185%		
230:	DC		410		
460:	DC		820		
	20				
	: 50%				

460V		A					B			C			D			E					
VFD-__C__		007	015	022	037	040	055	075	110	150	185	220	300	370	450	550	750	900	1100		
()	()	0.75	1.5	2.2	3.7	4.0	5.5	7.5	11	15	18.5	22	30	37	45	55	75	90	110		
(..)	(..)	1	2	3	5	5	7.5	10	15	20	25	30	40	50	60	75	100	125	150		
()	()	2.3	3.0	4.5	6.5	7.6	9.6	14	18	24	29	34	45	55	69	84	114	136	167		
(A)	(A)	2.9	3.8	5.7	8.1	9.5	11	17	23	30	36	43	57	69	86	105	143	171	209		
()	()	2-6																			
()	()	2.4	3.2	4.8	7.2	8.4	10	14	19	25	30	36	48	58	73	88	120	143	175		
(A)	(A)	3.0	4.0	6.0	9.0	10.5	12	18	24	32	38	45	60	73	91	110	150	180	220		
()	()	2-15					2-10					2-9									
(A)	(A)	4.1	5.6	8.3	13	14.5	16	19	25	33	38	45	60	70	96	108	149	159	197		
(A)	(A)	4.3	5.9	8.7	14	15.5	17	20	26	35	40	47	63	74	101	114	157	167	207		
/	/	3- AC 38 (-15%)...480 (+10%), 50/60																			
/	/	323~528Vac																			
/	/	47-63																			
EMI-	EMI-	VFDXXXC43A:					EMI-					VFDXXXC43A:					con du it box kit;VFDXXX43E: NEMA1				

0.01 / 2	
IEC60364-1/IEC60664-1	2,
NEMA 1/UL Type 1	2% 1°
UL Open Type	2% 1°
/	-25...+70°
/	.90%
/	.95%
/	86...106
/	70...106
IEC60721-3-3 (application is in progress)	
	Class 3C2; Class 3S2
	Class 2C2; Class 2S2
	Class 1C2; Class 1S2
	1000
/	2% 0.5°C 1000...3000, 100
1.5	, 3-13, 1G 13-200 (IEC 60068-2-31
15G	11 (IEC/EN 60068 2-27)
	±10°

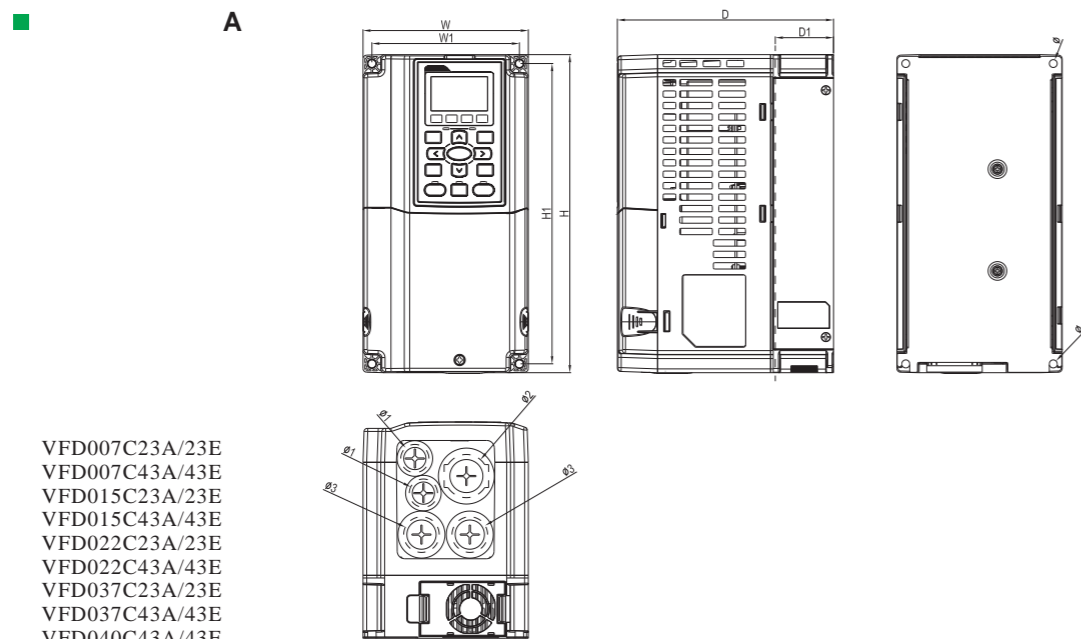

VFD007C23A/23E
 VFD007C43A/43E
 VFD015C23A/23E
 VFD015C43A/43E
 VFD022C23A/23E
 VFD022C43A/43E
 VFD037C23A/23E
 VFD037C43A/43E
 VFD040C43A/43E
 VFD055C43A/43E

	W	H	D	W1	H1	D1*	Ø	Ø1	Ø2	Ø3
A	130.0	250.0	170.0	116.0	236.0	45.8	6.2	22.2	34.0	28.0
	5.12	9.84	6.69	4.57	9.29	1.80	0.24	0.87	1.34	1.10

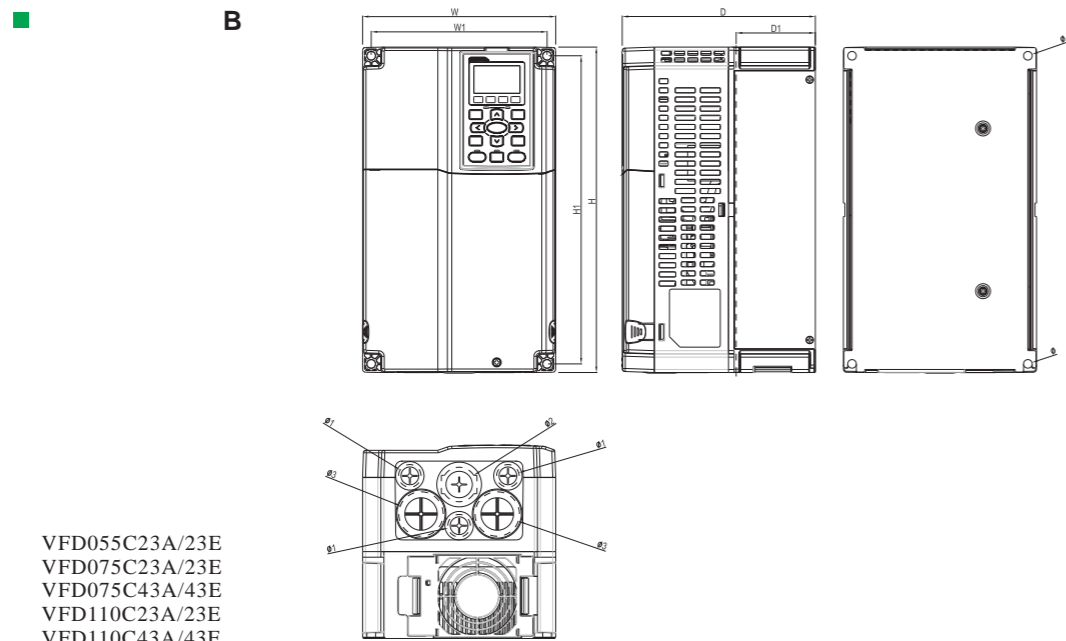

VFD055C23A/23E
 VFD075C23A/23E
 VFD075C43A/43E
 VFD110C23A/23E
 VFD110C43A/43E
 VFD150C43A/43E

	W	H	D	W1	H1	D1*	Ø	Ø1	Ø2	Ø3
B	190.0	320.0	190.0	173.0	303.0	77.9	8.5	22.2	34.0	43.8
	7.48	12.60	7.48	6.81	11.93	3.07	0.33	0.87	1.34	1.72

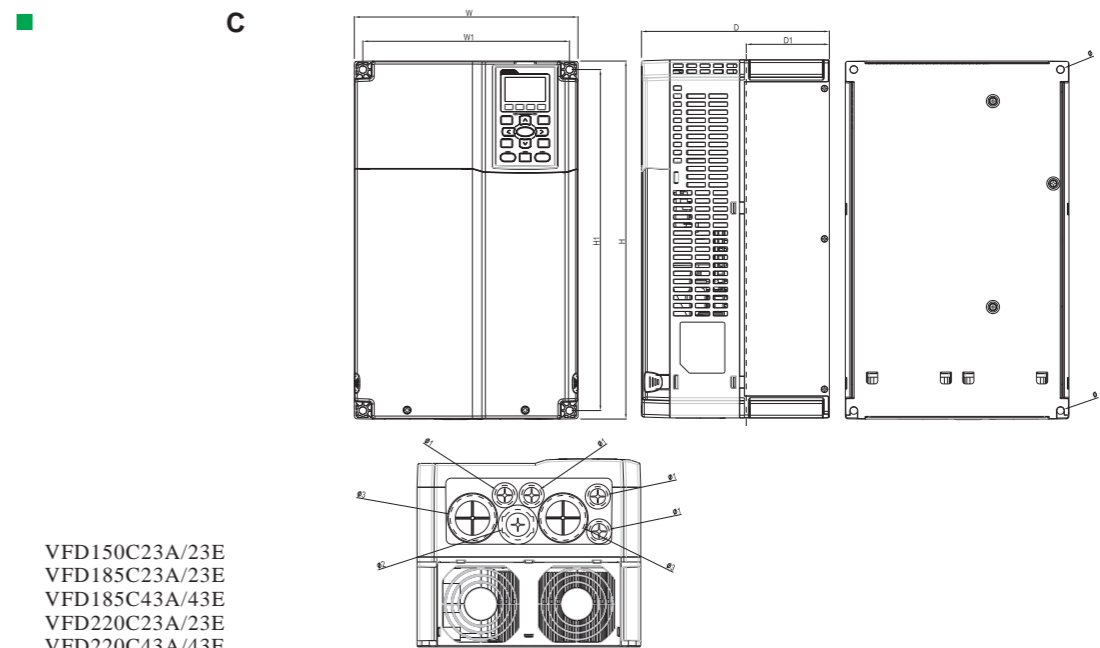

VFD150C23A/23E
 VFD185C23A/23E
 VFD185C43A/43E
 VFD220C23A/23E
 VFD220C43A/43E
 VFD300C43A/43E

	W	H	D	W1	H1	D1*	Ø	Ø1	Ø2	Ø3
C	250.0	400.0	210.0	231.0	381.0	92.9	8.5	22.2	34.0	50.0
	9.84	15.75	8.27	9.09	15.00	3.66	0.33	0.87	1.34	1.97

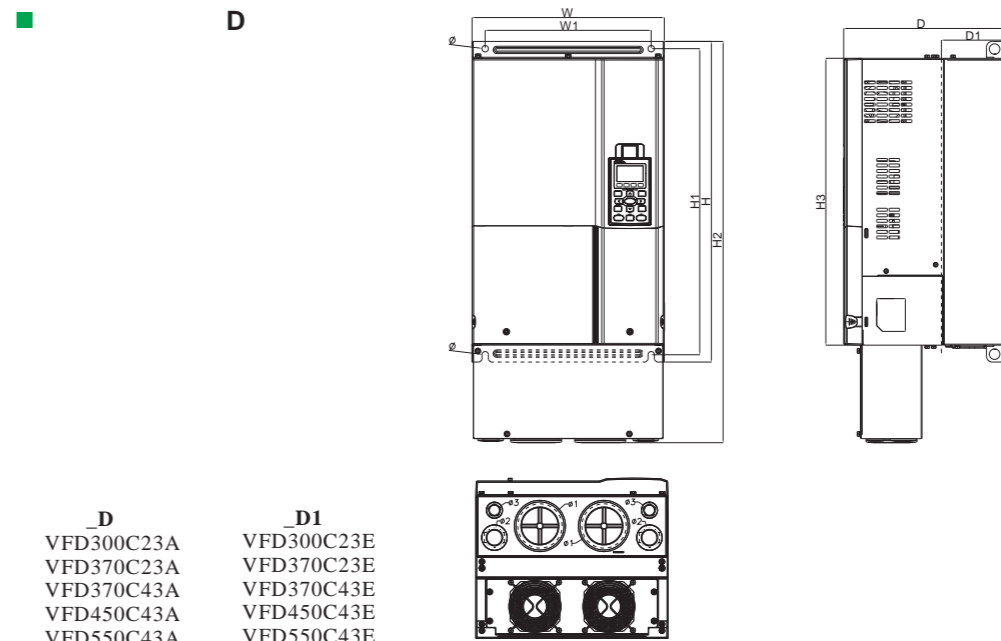

_D
 VFD300C23A
 VFD370C23A
 VFD370C43A
 VFD450C43A
 VFD550C43A
 VFD750C43A

_D1
 VFD300C23E
 VFD370C23E
 VFD370C43E
 VFD450C43E
 VFD550C43E
 VFD750C43E

	W	H	D	W1	H1	H2	H3	D1*	Ø	Ø1	Ø2	Ø3
D	330.0 [12.99]	550.0 [21.65]	275.0 [10.83]	285.0 [11.22]	525.0 [20.67]	-	492.0 [19.37]	107.2 [4.22]	11.0 [0.43]	34.0 [1.34]	22.0 [0.87]	11.0 [0.43]
D1	330.0 [12.99]	550.0 [21.65]	275.0 [10.83]	285.0 [11.22]	525.0 [20.67]	688.3 [27.10]	492.0 [19.37]	107.2 [4.22]	11.0 [0.43]	34.0 [1.34]	22.0 [0.87]	11.0 [0.43]

E

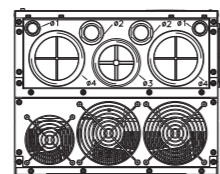
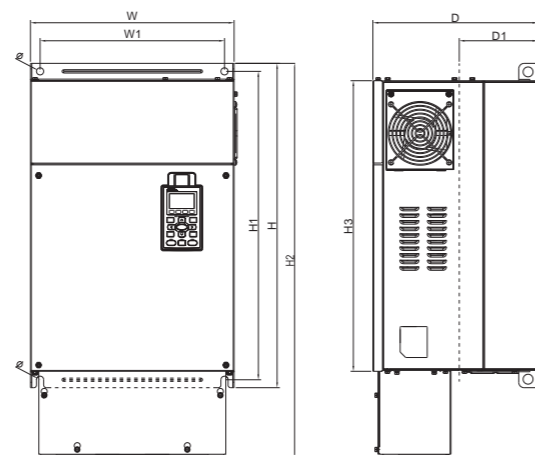

- | | |
|-------------|-------------|
| _E | _E1 |
| VFD450C23A | VFD450C23E |
| VFD550C23A | VFD550C23E |
| VFD900C43A | VFD900C43E |
| VFD1100C43A | VFD1100C43E |

	W	H	D	W1	H1	H2	H3	D1*	Ø	Ø1	Ø2	Ø3	Ø4
E	370.0 [14.57]	589.0 [23.19]	300.0 [11.81]	335.0 [13.19]	560.0 [22.05]	-	528.0 [20.80]	143.0 [5.63]	13.0 [0.51]	22.0 [0.87]	34.0 [1.34]	76.0 [2.99]	92.0 [3.62]
E1	370.0 [14.57]	589.0 [23.19]	300.0 [11.81]	335.0 [13.19]	560.0 [22.05]	715.8 [28.18]	528.0 [20.80]	143.0 [5.63]	13.0 [0.51]	22.0 [0.87]	34.0 [1.34]	76.0 [2.99]	92.0 [3.62]

E1*:

